



Corrugated Steel (CSP) Pipe

Superior structural strength in a durable and lightweight product.



APPLICATIONS INCLUDE:

Culverts | Storm Sewers | Storm Water Detention Tanks | Utilidors | More!



From culverts to pole cribs, no other product works harder than **CSP**.

CORRUGATED STEEL PIPE (CSP) AND RELATED PRODUCTS

Corrugated steel pipe has been successfully used in infrastructure across North America and around the world since the late 1890s. It is a trusted material that combines strength, light weight, flexibility and adaptability. The economy of CSP is second to none. No other material can beat its low up-front and total life cycle costs. Combine this with a service life of up to 100 years, and the choice is clear!

Armtec CSP is manufactured in Canada to the highest standard of quality and performance. With a variety of shapes, sizes, coating and material options, Armtec CSP products will meet the demands of your most challenging drainage projects.



STEELCOR

Galvanized CSP formed with helical corrugations and a continuous lock-seam combines flexibility with high compressive strength.

cspi ARMTEC IS A MEMBER OF THE
CORRUGATED STEEL PIPE INSTITUTE (CSPI)



NESTABLE PIPE

Versatile half-round segments of corrugated steel in flange nestable type configuration for ease of transportation.



ULTRA-FLO

Large diameter storm sewer pipe delivering superior hydraulic performance.



CSP END SECTIONS

Lightweight end sections for improved hydraulic performance and erosion control.

ARMTEC CSP can tackle any condition Canada can throw at it.

Steel Pipe Coatings to Match the Environment

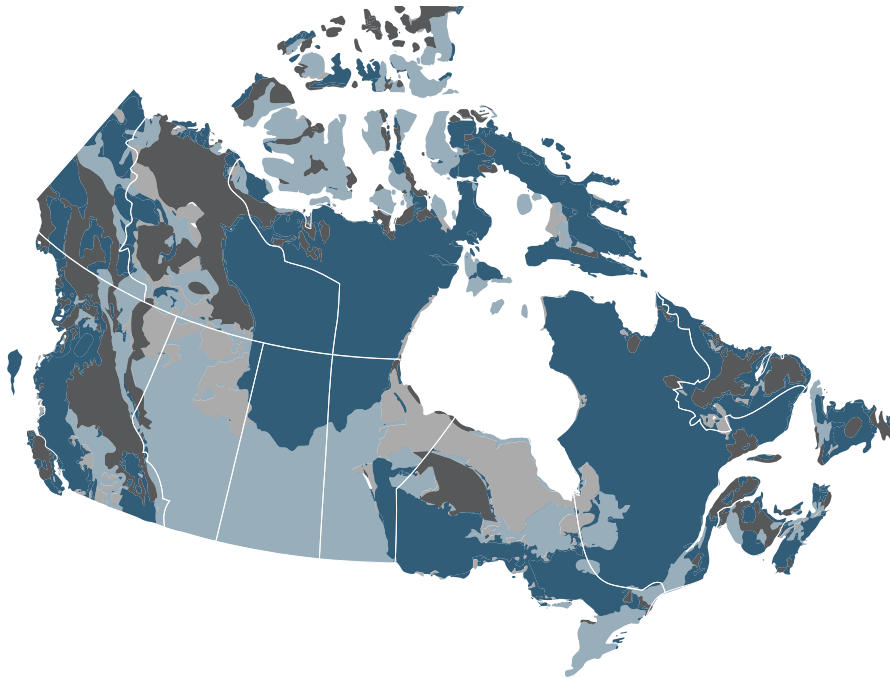

Surface Water Sensitivity to Atmospheric Pollutants

- Highly sensitive to acidification (i.e. low pH, elevated chloride and sulphate levels, low calcium carbonate levels [soft water]). Polymer laminated coating may be required.
- Moderately sensitive to acidification (i.e. moderate pH, medium to low calcium carbonate levels). Aluminized Type 2 coating may be required.
- Unlikely to be negatively influenced by atmospheric pollutants. Galvanized steel should be sufficient.
- Unrated



BACKED BY SCIENCE – Armtec can provide industry technical bulletins (for pH, chlorides, hardness and resistivity) to help you specify the right coating for your required service life.

OPTIMUM OPERATING RANGE OF VARIOUS PIPE COATINGS

pH

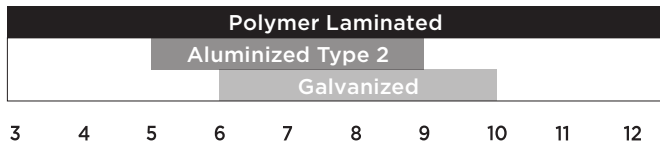

Hardness CaCO₃

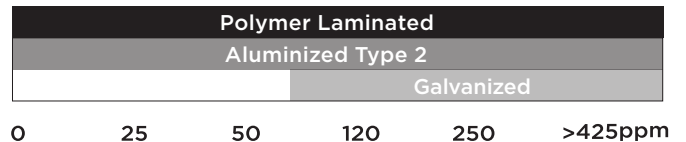

Chlorides (Cl)

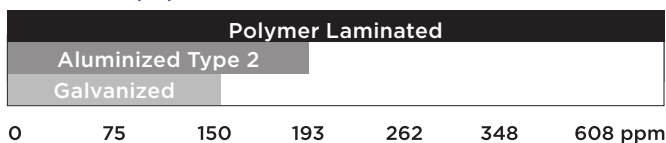

Resistivity Ohm - cm

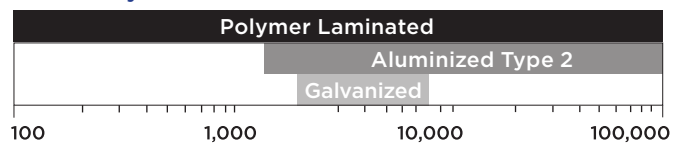

NOTE: BASED ON CSPI TECHNICAL BULLETIN ISSUE 1

CSP COATINGS AND DESIGN SERVICE LIFE

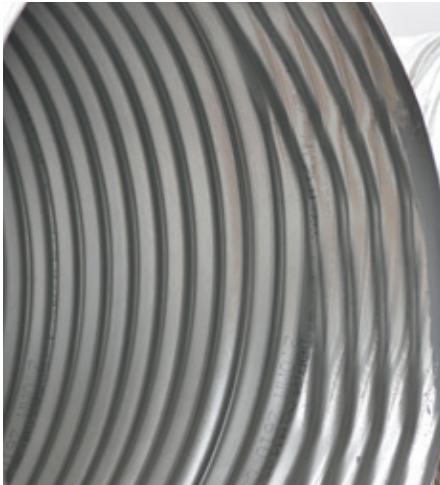

50
YEARS

GALVANIZED STEEL

Galvanized steel is the standard finish for corrugated steel pipe. It performs well in low abrasion applications and in site conditions with a relatively neutral environment. Galvanized steel has a proven service life of 50 years minimum in non-aggressive (or ideal) site conditions. This is extended in hard water environments when the zinc coating reacts with the calcium carbonate (CaCO_3) in the water to form an additional protective mineral scale.



75
YEARS

ALUMINIZED STEEL TYPE 2

Aluminized Steel Type 2 pipe combines the corrosion resistant properties of aluminum with the strength and durability of CSP. It is fabricated from steel coils, and hot-dip coated with a uniform thickness on both sides. It tolerates soft water and slightly more acidic and saline conditions than galvanized steel. With a 75 year service life in its optimal operating range, it is an economical alternative to concrete pipe.

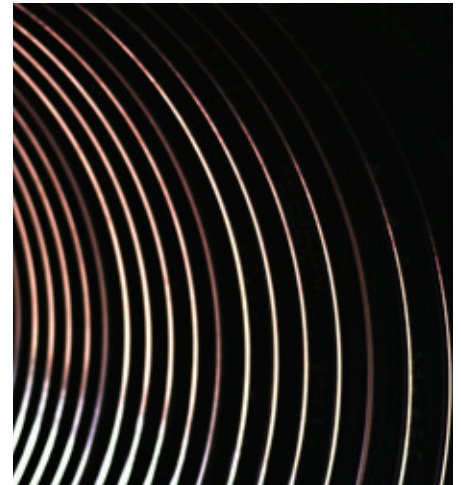

100
YEARS

POLYMER-LAMINATE

Polymer-Laminate coating such as Trenchcoat can extend the service life of CSP to 100 years. The strong adhesion characteristics of the polymer laminate with the galvanized sheet makes it the most durable coating available today. This rugged laminate creates a protective barrier against corrosive and abrasive conditions, and maintains its service life across a broad pH spectrum.

Find out more about the durability of CSP at www.cspi.ca

STEELCOR CORRUGATED STEEL PIPE

Since 1934, SteelCor pipe has proven its effectiveness and durability in countless installations under diverse conditions. Its helical corrugations and continuous lock-seam provide high compressive strength in a lightweight, thin-walled structure. SteelCor is available in a wide variety of sizes and various coating options. For ground water drainage, perforated SteelCor offers exceptional performance in low-lying areas, especially where high strength and hydraulic capacity are required.

TYPICAL APPLICATIONS

- Culverts
- Storm sewers
- Stormwater detention tanks
- Stream enclosures
- Underpasses
- Pipeline intakes
- Pipeline outfalls
- Storage relief tanks
- Caissons
- Cooling water lines

FLEXIBILITY AND STRENGTH

Helical corrugation combines strength and flexibility in a thin walled structure

HUGGER BAND

Hugger band couplers provide a superior joint with improved water tightness

VERSATILE

Variety of sizes, corrugation profiles and coating options

QUICK INSTALLATION

Lightweight and available in long lengths, minimizing installation time

COST-EFFECTIVE

- Low installed cost
- Nestable pieces for economical shipping



STEELCOR IS AVAILABLE IN LONG LENGTHS, MINIMIZING INSTALLATION TIME

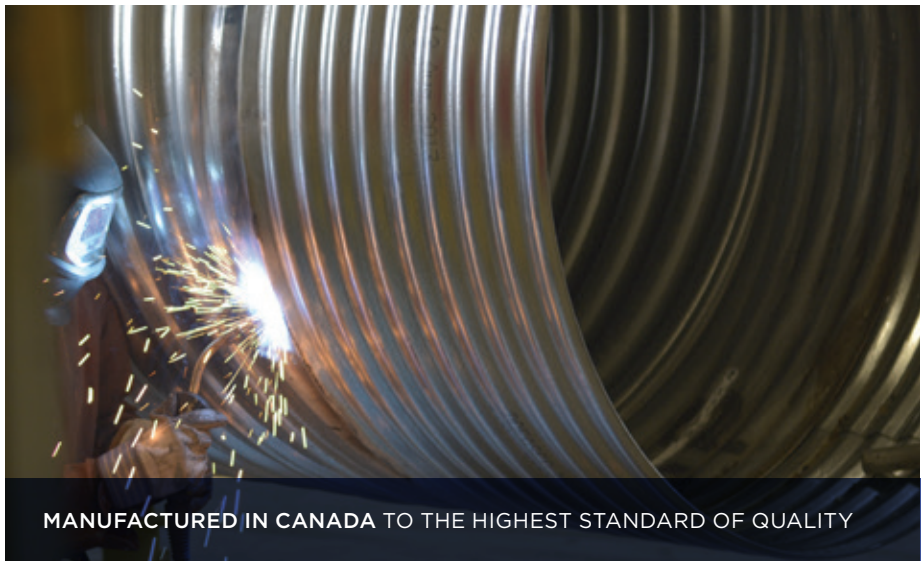

MANUFACTURED IN CANADA TO THE HIGHEST STANDARD OF QUALITY

FLEXIBILITY AND HIGH COMPRESSIVE STRENGTH

CSP is categorized as a flexible pipe. The corrugated profile of the pipe wall provides a high degree of relative stiffness which, when combined with a properly-installed engineered backfill, provides for high circumferential strength in a thin-walled structure. The compacted fill acts together with the pipe wall to form a composite soil-steel structure.

RING COMPRESSION THEORY

The compressive thrust in the pipe wall is equal to the radial pressure acting on the wall multiplied by the wall radius. In other words, pressure distribution around a flexible pipe is more uniform and load is more evenly distributed in the flexible pipe vs. the rigid pipe (i.e. concrete). Pipe wall thickness can be reduced and less bedding material is required for flexible CSP to achieve the same buried strength as a rigid pipe system.

Table 1: Available Corrugation Profiles & Diameters of CSP Pipe

Corrugation	Pitch	Depth	Inside Diameter
mm x mm	mm	mm	mm
38 x 6.5	38	6.5	150, 200, 250
68 x 13	68	13	300 - 2,000
125 x 25	125	25	1,200 - 3,600

Load Distribution - Rigid Pipe

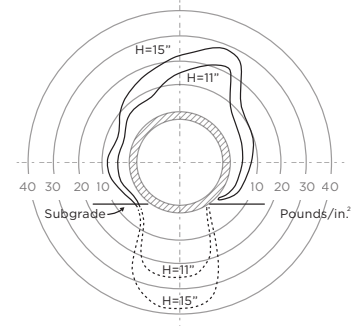

Load Distribution - Flexible Pipe

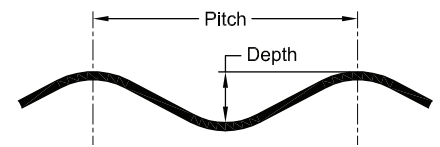
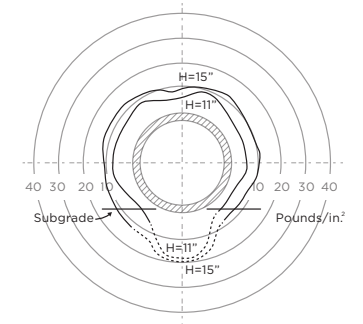

SteelCor Shapes

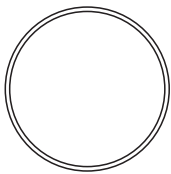

ROUND

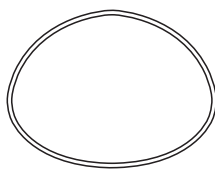

PIPE ARCH



STEELCOR CSP IS AVAILABLE IN LARGE DIAMETERS UP TO 3,600MM



CSP PIPE ARCH

PIPE ARCH is available for projects where vertical space is limited.

COUPLERS

SteelCor pipe features universal annular corrugated ends, so a variety of couplings may be used for the pipe and pipe-arch. Annular corrugated couplers are standard for municipal and highway drainage. Hugger Band couplers are standard for storm sewer applications and Dimpled couplers are often used in forestry.

Three types of couplers are available:

- Annular corrugated standard bolt and angle coupler
- Dimpled coupling band
- Hugger Band

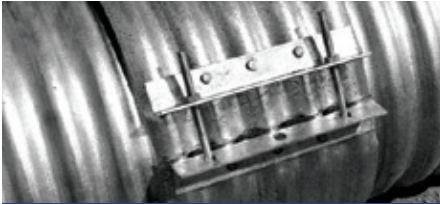

STANDARD ANNULAR CORRUGATED COUPLER

The standard annular corrugated coupler, fitted with bolt and angle attachments, seats snugly onto the pipe-end corrugations, and is suitable for most general-purpose applications. It comes in one, two or three piece configurations depending on the pipe diameter.

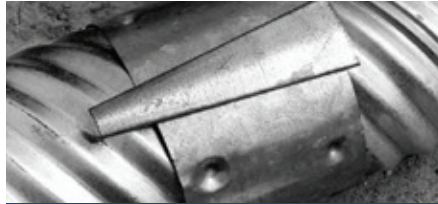

DIMPLED COUPLING BAND

This coupler is used where helical and/or annular corrugated pipe ends are to be coupled. Dimpled couplers are available with steel angle connectors as shown.



HUGGER BAND

Armtec offers a highly effective Hugger Band joint. These 500mm wide bands are recommended for storm sewers and other installations where low leakage rates and resistance to longitudinal disjoints are prime requirements. When used with O-ring gaskets, the Hugger Band provides an extremely tight joint with low infiltration and exfiltration rates.

Hugger Band Couplers for CSP joints are comprised of the following components:

- Semi-corrugated coupler sheet to accommodate placing elastomeric O-rings at both re-corrugated pipe ends
- Bolted bar and strap connector at coupler sheet lap(s) to maximize joint pull-apart strength
- O-rings in combination with neoprene gasket at coupler sheet lap(s) to minimize joint leakage and/or joint infiltration

H-500 HUGGER BAND (DOUBLE BOLT, BAR AND STRAP)

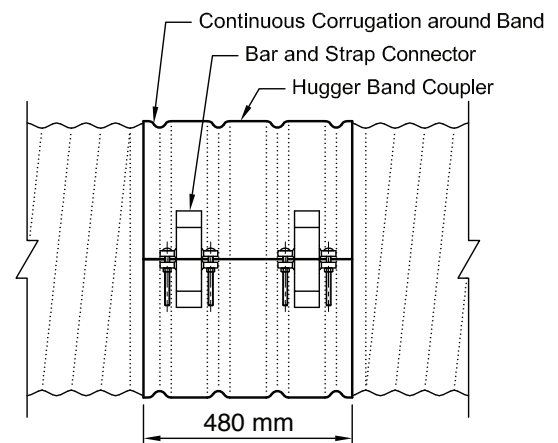
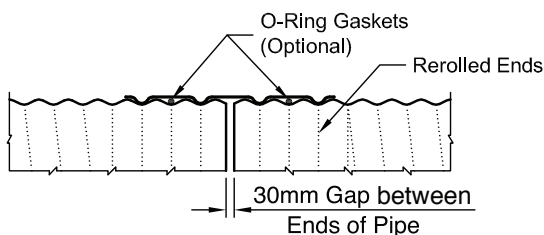

Fittings

Standard fittings such as tees, wyes and elbows are available. Special fittings such as saddle branches, manholes and catch-basins can be custom-fabricated to suit individual requirements.



CSP CAN BE FABRICATED TO SUIT A MULTITUDE OF CONFIGURATIONS



CUSTOM FITTINGS AVAILABLE



GALVANIZED CSP STORMWATER TANK SYSTEM

Typical Fittings

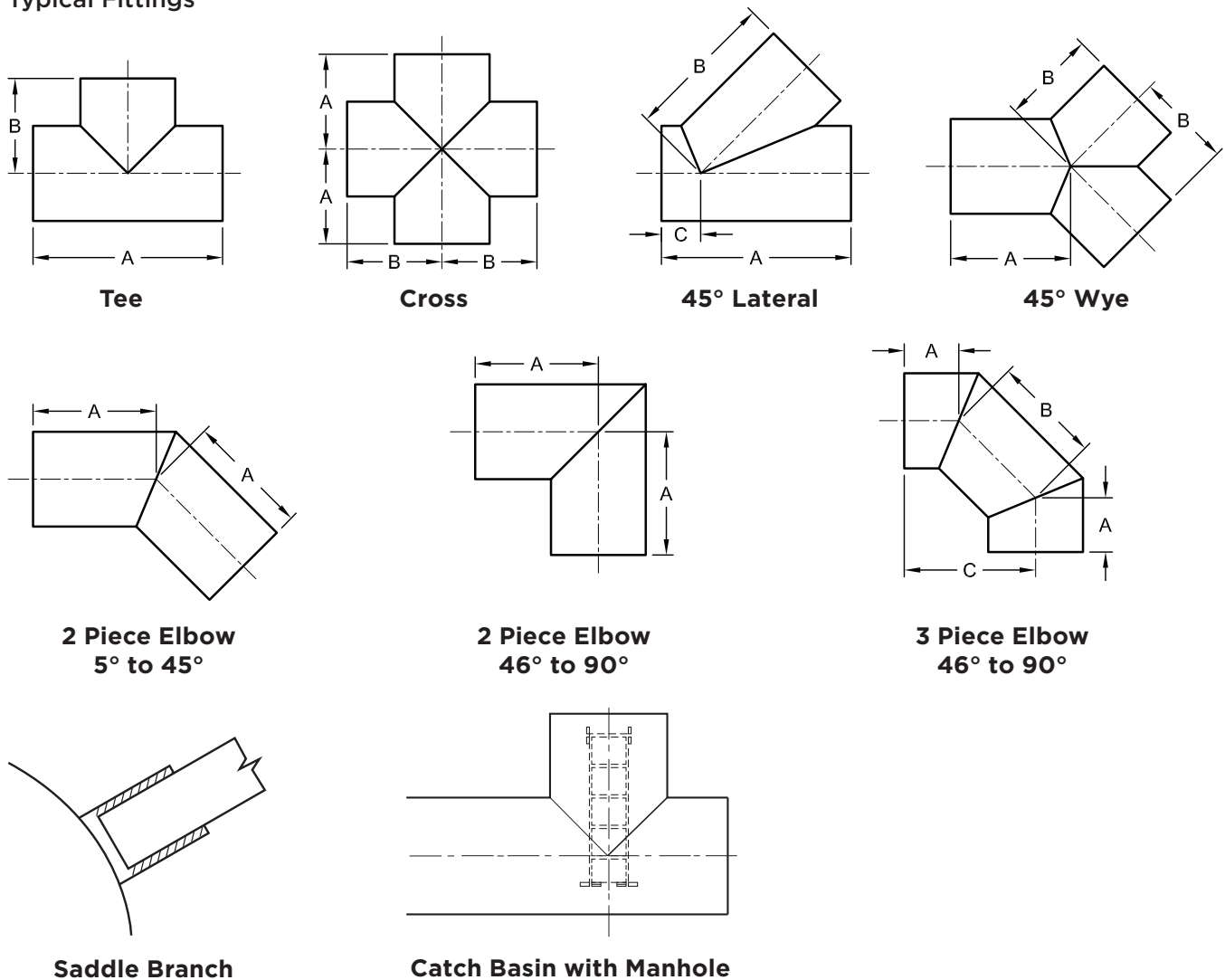

STEELCOR PIPE AND PIPE-ARCH TECHNICAL SPECIFICATIONS

68 mm x 13 mm Corrugations

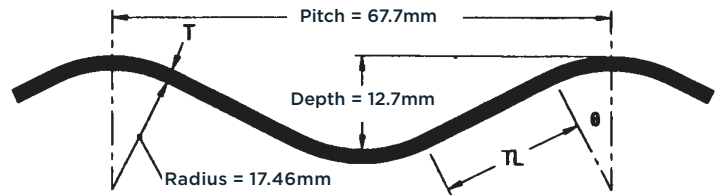

Table 2: Section Properties of 68 mm x 13 mm Corrugated CSP

Coated Thickness	Design Thickness	Area of Section	Moment of Inertia	Section Modulus	Radius of Gyration	Tangent Length	Tangent Angle
mm	mm	mm ² /mm	mm ⁴ /mm	mm ³ /mm	mm	mm	° degrees
1.6	1.42	1.512	28.367	4.024	4.332	19.578	26.734
2.0	1.82	1.966	37.108	5.111	4.345	19.304	26.867
2.8	2.64	2.852	54.565	7.114	4.374	18.765	27.136
3.5	3.35	3.621	70.159	8.743	4.402	18.269	27.381
4.2	4.08	4.411	86.706	10.334	4.433	17.755	27.643

NOTE:

¹ 4.2 MM COATED THICKNESS IS SPECIAL ORDER AND NOT AVAILABLE IN ALL REGIONS.

Table 3: Handling Weight and End Area of 68 mm x 13 mm Corrugated CSP

Pipe Diameter	End Area	Handling Weight - Galvanized (kg/m) for the Following Specified Wall Thickness (mm)					
		1.3 mm	1.6 mm	2.0 mm	2.8 mm	3.5 mm	4.2 mm
150 ¹	0.018	5.9	7.2	-	-	-	-
200 ¹	0.031	7.7	9.5	-	-	-	-
250 ¹	0.049	9.6	12	-	-	-	-
300	0.071	-	14	18	-	-	-
400	0.126	-	19	24	-	-	-
500	0.196	-	24	30	-	-	-
600	0.283	-	28	35	49	-	-
700	0.385	-	33	41	57	-	-
800	0.503	-	37	47	65	-	-
900	0.636	-	42	53	73	90	-
1,000	0.785	-	-	58	81	100	-
1,200	1.131	-	-	70	97	120	-
1,400	1.539	-	-	-	113	140	168
1,600	2.011	-	-	-	130	160	192
1,800	2.545	-	-	-	-	179	215
2,000	3.142	-	-	-	-	-	239

NOTE:

1. 150 MM TO 250 MM PIPE DIAMETER FABRICATED WITH 38 X 6.5 CORRUGATION PROFILE
2. FOR ADDITIONAL SIZES, PLEASE CONTACT AN ARMTEC REPRESENTATIVE
3. 4.2 MM COATED THICKNESS IS SPECIAL ORDER AND NOT AVAILABLE IN ALL REGIONS

STEELCOR PIPE AND PIPE-ARCH TECHNICAL SPECIFICATIONS

125 mm x 25 mm Corrugations

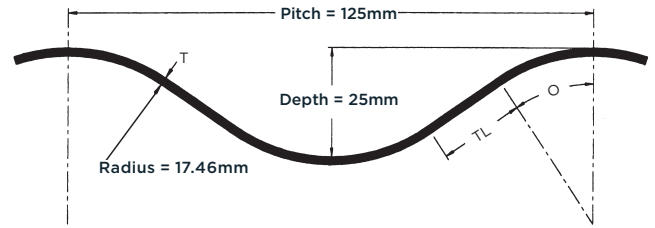

Table 4: Section Properties of 125 mm x 25 mm Corrugated CSP

Coated Thickness	Design Thickness	Area of Section	Moment of Inertia	Section Modulus	Radius of Gyration	Tangent Length	Tangent Angle
mm	mm	mm ² /mm	mm ⁴ /mm	mm ³ /mm	mm	mm	° degrees
2.0	1.82	2.014	173.72	12.49	9.287	17.970	35.811
2.8	2.64	2.923	253.24	17.68	9.308	16.742	36.330
3.5	3.35	3.711	322.74	21.99	9.326	15.600	36.826
4.2	4.08	4.521	394.84	26.25	9.345	14.332	37.392

NOTE:

1. 4.2 MM COATED THICKNESS IS SPECIAL ORDER AND NOT AVAILABLE IN ALL REGIONS.

Table 5: Handling Weight and End Area of 125 mm x 25 mm Corrugated CSP

Pipe Diameter	End Area	Handling Weight - Galvanized (kg/m) for the Following Specified Wall Thickness (mm)			
		2.0 mm	2.8 mm	3.5 mm	4.2 mm
mm	m ²				
1,200	1.131	71	100	124	-
1,400	1.539	83	116	144	-
1,600	2.011	95	132	165	197
1,800	2.545	106	148	185	221
2,000	3.142	118	165	205	245
2,200	3.801	129	181	225	269
2,400	4.524	141	197	245	293
2,700	5.726	159	222	276	330
3,000	7.069	-	246	306	366
3,300	8.553	-	270	336	402
3,600	10.179	-	-	367	438

NOTE:

1. 4.2 MM COATED THICKNESS IS SPECIAL ORDER AND NOT AVAILABLE IN ALL REGIONS.

STEELCOR PIPE HEIGHT OF COVER LIMITS

CL-625 and AREMA Cooper E-80 Live Loading

Table 6: 68 mm x 13 mm Corrugations

Minimum Cover (mm)			Maximum Height of Cover (m) for the Following Specified Wall Thickness (mm)				
Diameter	Highway	Railway	1.6mm	2.0mm	2.8mm	3.5mm	4.2mm
mm	CL-625	E-80					
300	300	300	70	91	-	-	-
400	300	300	53	68	-	-	-
500	300	300	42	54	-	-	-
600	300	300	35	45	66	-	-
700	300	300	30	39	57	-	-
800	300	300	26	34	50	-	-
900	300	300	23	30	44	56	70
1,000	300	300	21	27	40	50	63
1,200	300	300	-	23	33	42	52
1,400	300	500	-	-	27	35	43
1,600	300	500	-	-	22	28	35
1,800	500	500	-	-	-	22	27
2,000	500	500	-	-	-	-	22

Table 7: 125 mm x 25 mm Corrugations

Minimum Cover (mm)			Maximum Height of Cover (m) for the Following Specified Wall Thickness (mm)			
Diameter	Highway	Railway	1.6mm	2.0mm	2.8mm	3.5mm
mm	CL-625	E-80				
1,200	300	500	18	23	34	-
1,400	300	500	15	20	29	35
1,600	300	500	13	18	25	31
1,800	300	500	12	16	22	28
2,000	300	500	11	14	20	25
2,200	300	700	10	12	18	23
2,400	500	700	-	11	17	21
2,700	500	700	-	-	15	18
3,000	500	1,000	-	-	13	16
3,300	500	1,000	-	-	-	14
3,600*	700	1,000	-	-	-	12*

NOTES:

* FLEXIBILITY LIMIT EXCEEDED - FOR SPECIFIED USE ONLY

1. DEAD LOAD IS BASED ON A UNIT WEIGHT OF BACKFILL OF 19 KN/M³

2. WHERE HEIGHT OF COVER EXCEEDS THE DIAMETER, A REDUCTION LOAD FACTOR OF 0.86 HAS BEEN USED

3. LIVE LOAD INCLUDES IMPACT

4. MINIMUM COVER IS TAKEN FROM TOP OF PIPE TO PROFILE GRADE OR TO THE TOP OF THE FINISHED GRANULAR BASE

5. SPECIAL CARE MUST BE TAKEN WITH TRUCK LOADS DURING CONSTRUCTION

6. FOUNDATION INVESTIGATION IS RECOMMENDED PRACTICE

7. THE ABOVE HEIGHT OF COVER TABLES ARE INDUSTRY STANDARDS. LOCAL, PROVINCIAL OR FEDERAL STANDARDS MAY DIFFER

STEELCOR PIPE ARCH DETAILS

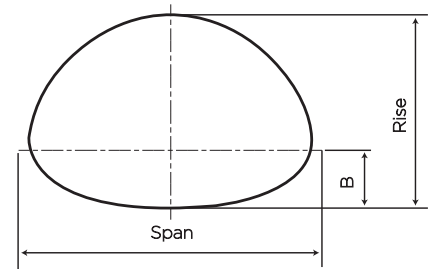

Table 8a: 68 mm x 13 mm Corrugations

Diameter of Pipe of Equal Periphery	Span	Rise	B	Waterway Area
mm	mm	mm	mm	m ²
400	450	340	130	0.11
500	560	420	165	0.19
600	680	500	190	0.27
700	800	580	220	0.37
800	910	660	255	0.48
900	1,030	740	265	0.61
1,000	1,150	820	310	0.74
1,200	1,390	970	375	1.06
1,400	1,630	1,120	430	1.44
1,600	1,880	1,260	500	1.87
1,800	2,130	1,400	560	2.36

Table 8b: 125 mm x 25 mm Corrugations (where available)

Diameter of Pipe of Equal Periphery	Span	Rise	B	Waterway Area
mm	mm	mm	mm	m ²
1,600	1,780	1,360	635	1.93
1,800	2,010	1,530	650	2.44
2,000	2,230	1,700	660	2.97
2,200	2,500	1,830	750	3.44
2,400	2,800	1,950	805	4.27
2,700	3,300	2,080	905	5.39
3,000	3,650	2,280	1,005	6.60
3,300	3,890	2,690	1,090	8.29
3,600	4,370	2,890	1,195	9.76

NOTES:

FOR WEIGHTS OF PIPE-ARCHES WITH THE 68 X 13 CORRUGATION REFER TO THE WEIGHT OF THE CIRCULAR PIPE WITH THE EQUIVALENT PERIPHERY. NOT ALL SIZES ARE AVAILABLE IN ALL LOCATIONS. PLEASE CONTACT AN ARMTEC REPRESENTATIVE FOR FURTHER DETAILS

Table 9a: Height of Cover Limits for 68 mm x 13 mm Corrugated Steel Pipe-Arch CL-625 Live Load

Span	Rise	Minimum Cover	Maximum Height of Cover (m) for Corner Bearing Pressure Limited to 200 kPa and the Following Specified Wall thickness				
			1.6mm	2.0mm	2.8mm	3.5mm	4.2mm
mm	mm	mm					
560	420	300		4.1			
680	500	300		4.2			
800	580	300		4.1			
910	660	300		4.1			
1030	740	300		4.0			
1150	820	300			4.0		
1390	970	300			3.9		
1630	1120	300				3.9	
1880	1260	350					3.8
2130	1400	400					3.7

Table 9b: Height of Cover Limits for 125 mm x 25 mm Corrugated Steel Pipe-Arch CL-625 Live Load

Span	Rise	Minimum Cover	Maximum Height of Cover (m) for Corner Bearing Pressure Limited to 200 kPa and the Following Specified Wall thickness					
			1.6mm	2.0mm	2.8mm	3.5mm	4.2mm	
mm	mm	mm						
1780	1360	300					4.4	
2010	1530	350					4.3	
2230	1700	400					4.6	
2500	1830	450					4.5	
2800	1950	500					4.4	
3300	2080	550					4.3	
3650	2280	650					4.2	
3890	2690	650					3.5	
4370	2870	750					3.0 ⁴	3.0

NOTES:

1. FILL HEIGHTS BASED ON AISI DESIGN METHOD
2. CL-625 LIVE LOAD
3. MAXIMUM APPLIED CORNER BEARING PRESSURE 200 KPA
4. EXCEEDS FLEXIBILITY, SPECIAL ATTENTION REQUIRED FOR BACKFILL MATERIAL AND CONSTRUCTION PROCESS

PERFORATED STEELCOR PIPE FOR GROUND WATER CONTROL

Perforated SteelCor is widely accepted as a practical, durable and economical means of controlling unwanted ground water. It is an efficient solution and costs less than repeated surface repairs, virtually eliminating maintenance concerns. Perforated SteelCor pipe is available in plain galvanized and suitable for most applications, however it is strongly recommended that consideration be given to using either Aluminized Steel Type 2 or Polymer Coated in particularly aggressive environments.

Pipe Size Selection

For normal subdrainage, the infiltration of ground water is very slow. Therefore, approximately 150 metres of 150mm diameter pipe may be used as an interceptor before any increase in pipe diameter is required. Where extremely pervious material is being drained or where springs are encountered, larger sizes may be required.

Pipe Outlets

Perforated pipe's cantilever strength makes it ideal for use as a projecting pipe outlet.

Free outlets are important, and the failure of subdrains to properly function can often be attributed to plugged, damaged or improper outlets. Outlet pipes should be protected from damage by maintenance equipment. A suitable barrier such as a hinged rodent trap should be used to keep out wildlife whose nests could cause clogging.

Spacing of Laterals

Draining large, comparatively flat areas usually requires a parallel or herringbone system of drainage pipe. The spacing used on highways and railways is controlled by the location of the water-bearing strata.

Filter Sock and Geotextiles

Geotextile is widely used in perforated pipe applications, particularly where graded filter material is not available. More critical installations call for a high quality non-woven geotextile to separate the trenchfill from the native material. Armtec can also provide a low-cost knitted polyester sock to encase the pipe. This polyester sock is available custom sewn around the pipe.

Recommended Backfill

The trench should be excavated with approximately 100mm of clearance at the sides of the pipe (for small diameters) so that pervious backfill can surround the pipe. For the filter backfill, concrete sand or other commonly available coarse sand-gravel mixtures perform satisfactorily for perforated pipe in most soils.

Placing of Perforations

Armtec recommends that the pipe be placed with the perforations down. This hinders solids from entering the pipe and keeps the water table lower.

Table 10: Dimensions, Thicknesses and Spacing of Perforations*

Nominal Internal Diameter	Corrugation Profile	Normal Thickness Specified	Minimum No. of Rows of Perforations	Minimum Width Unperforated Segment	Distance Between Holes Along the Longitudinal Axis	Perforated Area
mm	mm	mm		mm	mm	cm ² /m
150	38 x 6.5	1.6	4	125	38	74.61
200	38 x 6.5	1.6	4	160	38	74.61
250	38 x 6.5	1.6	4	195	38	74.61
300	68 x 13	1.6	6	235	136	31.27
400	68 x 13	1.6	6	310	136	31.27

NOTE:

* ALL PERFORATIONS ARE A NOMINAL 9.5MM DIAMETER

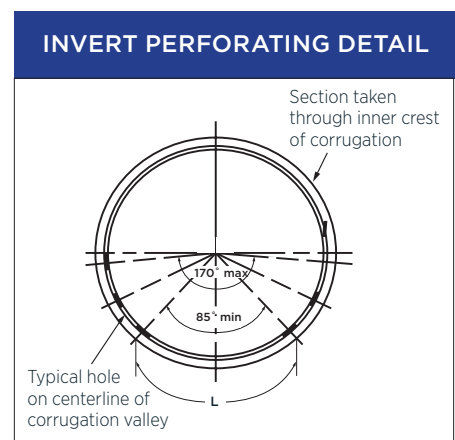

NOTE :

* RANDOM HOLE SPACING AROUND THE CIRCUMFERENCE IS AVAILABLE ON REQUEST

STEELCOR CSP INSTALLATION

Bedding and Backfilling

Well graded, free draining backfill is recommended for good compaction. The designer may wish to refer to the gradation and backfill specifications of the appropriate provincial highway standard. Stumps, rocks, frozen lumps and other debris should be removed from the bedding site.

Round pipe can be installed on a flat sand cushion with rodding and tamping of the backfill around the haunches. Alternatively, the pipe can be installed on a pre-shaped granular base.

The pipe-arch invert must be placed on a pre-shaped sand cushion. The support under the invert should be relatively yielding but under the corner haunches the supporting ground must be highly stable. Special attention should be given to compacting the backfill around the corner haunches where the highest soil pressures develop.

Backfill should be spread in 150 mm to 200mm lifts alternating from one side of the pipe to the other, and should extend above the pipe to a minimum height of 300 mm or as stated in the height of cover limit tables for the corrugation profile (whichever is greater).

Compaction using suitable mechanical equipment should be carried out to achieve the specified backfill density. Care must be taken to ensure that the pipe or pipe arch is not damaged by heavy equipment traffic during construction.

Complete installation guidelines can be found in the CSPI Handbook of Steel Drainage and Highway Construction.



STEELCOR'S LIGHTWEIGHT SECTIONS ALLOW INSTALLATION WITHOUT THE NEED FOR HEAVY EQUIPMENT



HELICAL CORRUGATIONS AND CONTINUOUS LOCK-SEAM PROVIDE STRENGTH IN A LIGHTWEIGHT STRUCTURE

ULTRA FLO CORRUGATED STEEL PIPE

Ultra Flo is a durable storm sewer pipe with a unique external rib corrugation and smooth pipe interior that provides superior hydraulic performance at an economical price. It is available in round or pipe arch shapes for applications with vertical limitations. Materials include Galvanized Steel, Aluminized Steel Type 2 and Polymer-Laminate.

Ultra Flo pipe is produced by a continuous spiral seam method. Stiffness is provided by 19 mm x 19 mm x 190 mm continuous external box-shaped rib corrugations. Ultra Flo performs as a flexible compression ring under load, redistributing pressure radially into the surrounding high-density soil. The unit pressure at the pipe invert can be as little as one-third of the unit pressure under a concrete pipe in identical loading conditions.

TYPICAL APPLICATIONS

- Municipal storm sewers, in large diameter
- Highway median drainage
- Industrial storm sewers
- Large diameter culverts
- Slip-lines
- Stormwater detention tanks



ULTRA FLO'S EXTERIOR BOX RIBS AND SMOOTH INTERIOR COMBINES STRENGTH WITH SUPERIOR HYDRAULIC PERFORMANCE

 **DURABLE**

Available in a wide variety of coatings to suit environmental conditions

 **EFFICIENT HYDRAULICS**

Ultra Flo's low "n" factor is equivalent to or less than the standard 0.013 usually used in storm sewer design

 **NESTABLE**

Efficient shipping for remote locations

 **QUICK INSTALLATION**

Lightweight and available in long lengths with minimal joints

 **ECONOMICAL**

Lowest installed cost compared to large-diameter concrete storm sewers

RIB PROFILE

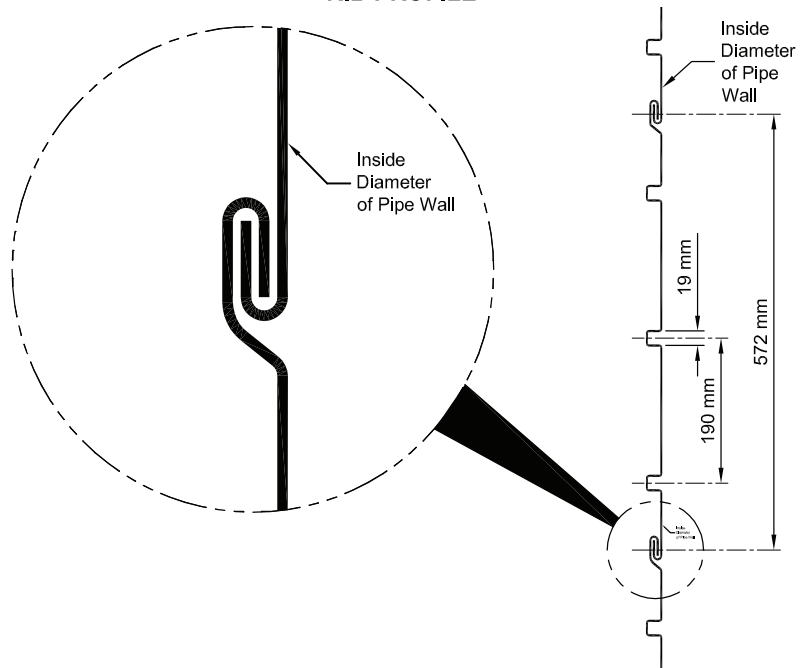

PIPE SIZES

Round (mm)	450, 525, 600, 750, 900, 1050, 1200, 1350, 1500, 1650, 1800, 2100, 2400
Arch, span x rise (mm)	500 x 410, 580 x 490, 680 x 540, 830 x 660, 1010 x 790, 1160 x 920, 1340 x 1050, 1520 x 1200, 1670 x 1300, 1850 x 1400

FOR DETAILED PRODUCT INFORMATION, SEE ULTRA FLO PRODUCT GUIDE

Table 11: Height of Cover Table for Ultra Flo Round Pipe

			Maximum Height of Fill (m) for Metal Thickness (mm)		
Diameter	Area	Minimum Height of Fill	1.6mm	2.0mm	2.8mm
mm	m ²	mm			
450	0.16	300	22.7	22.7	
525	0.22	300	19.4	28.8	50.6
600	0.28	300	17.0	25.2	44.3
750	0.44	300	13.6	20.2	35.4
900	0.64	300	11.3	16.8	29.5
1,050	0.87	300	9.7	14.4	25.3
1,200	1.13	300	8.5*	12.6	22.1
1,350	1.43	340	7.5*	11.2	19.7
1,500	1.77	380	6.8*	10.1*	17.7
1,650	2.14	410		9.1*	16.1
1,800	2.54	450		8.4*	14.7
2,100	3.46	530			12.6*
2,400	4.52	600			11.0*
2,600	5.31	650			9.0*

NOTES:

1. ALLOWABLE MINIMUM COVER IS MEASURED FROM THE TOP OF PIPE TO THE BOTTOM OF A FLEXIBLE PAVEMENT OR TOP OF A RIGID PAVEMENT. MINIMUM COVER IN UNPAVED AREAS MUST BE MAINTAINED. BACKFILL IS ASSUMED TO BE COMPACTED TO A MINIMUM OF 95% STANDARD PROCTOR DRY DENSITY.
 2. ALL HEIGHTS OF COVER ARE BASED ON INSTALLATION IN A TRENCH. IF EMBANKMENT CONDITIONS EXIST, THERE MAY BE RESTRICTIONS ON GAUGES FOR LARGE DIAMETERS. YOUR ARMTEC REGION ENGINEER CAN PROVIDE YOU WITH FURTHER GUIDANCE.
 3. TABLES ARE FOR CL-625 LOADING ONLY. FOR HEAVY CONSTRUCTION LOADS, HIGHER MINIMUM COVERS MAY BE REQUIRED. YOUR ARMTEC REGION ENGINEER CAN PROVIDE YOU WITH FURTHER GUIDANCE.
- * THESE SIZES AND GAUGES REQUIRE SPECIAL ATTENTION TO BACKFILL MATERIAL AND CONSTRUCTION METHODS.

Table 12: Height of Cover Table for Ultra Flo Arch Pipe

					Maximum Height of Fill (m) to Limit Corner Bearing Pressure to a Maximum of 200 kPa for Metal Thickness (mm)		
Span	Rise	Equivalent Diameter	Area	Minimum Height of Fill	1.6mm	2.0mm	2.8mm
mm	mm	mm	m ²	mm			
500	410	450	0.15	300	4.0	4.0	
580	490	525	0.21	300	5.2	5.2	5.2
680	540	600	0.27	300	5.2	5.2	5.2
830	660	750	0.43	300	5.2	5.2	5.2
1,010	790	900	0.62	300	4.4	4.4	4.4
1,160	920	1,050	0.85	300	5.1	5.1	5.1
1,340	1,050	1,200	1.12	300		4.4	4.4
1,520	1,200	1,350	1.44	340		5.3*	5.3
1,670	1,300	1,500	1.79	380		5.1*	5.1
1,850	1,400	1,650	2.15	410		4.7*	4.7

NOTES:

1. ALLOWABLE MINIMUM COVER IS MEASURED FROM THE TOP OF PIPE TO THE BOTTOM OF A FLEXIBLE PAVEMENT OR TOP OF A RIGID PAVEMENT. MINIMUM COVER IN UNPAVED AREAS MUST BE MAINTAINED. BACKFILL IS ASSUMED TO BE COMPACTED TO A MINIMUM OF 95% STANDARD PROCTOR DRY DENSITY.
 2. ALL HEIGHTS OF COVER ARE BASED ON INSTALLATION IN A TRENCH. IF EMBANKMENT CONDITIONS EXIST, THERE MAY BE RESTRICTIONS ON GAUGES FOR LARGE DIAMETERS. YOUR ARMTEC REGION ENGINEER CAN PROVIDE YOU WITH FURTHER GUIDANCE.
 3. TABLES ARE FOR CL-625 LOADING ONLY. FOR HEAVY CONSTRUCTION LOADS, HIGHER MINIMUM COVERS MAY BE REQUIRED. YOUR ARMTEC REGION ENGINEER CAN PROVIDE YOU WITH FURTHER GUIDANCE.
- * THESE SIZES AND GAUGES REQUIRE SPECIAL ATTENTION TO BACKFILL MATERIAL AND CONSTRUCTION METHODS.

END TREATMENTS

Armtec supplies durable, lightweight end sections for improved hydraulic efficiency and erosion control. These sections help reduce scour at inlets, undermining at outlets and provide an attractive and economical means of blending culvert ends with a sloping embankment.

The end sections are positioned with light equipment and clamp onto the culvert. In the case of the smaller available sections, no equipment is required to position the end sections. Earth is compacted around the sloping ends to complete the installation.

STANDARD END SECTIONS are suitable for CSP up to 2,400 mm in diameter and pipe arches up to 1,880 mm x 1,260 mm. They can be reused if lengthening or relocation is necessary.

SAFETY SLOPE END SECTIONS suit corrugated steel pipes up to 1,400 mm diameter and pipe arches up to 2,130 mm span x 1,400 mm rise. Safety slope end sections are also available with parallel cross bars and are built with a 4:1 or 6:1 slope. The flatter slopes on roadside embankments have been shown to improve highway safety.



CSP END SECTION WITH FUNCTIONAL GRATE



CSP END SECTION WITH OPTIONAL TOE PLATE EXTENSION



SLOPE RETENTION

Designed to support and retain slope grade and material



ECONOMICAL

Culvert repairs are reduced with the reduction of scour at the inlet and undermining at the outlet



ATTRACTIVE SOLUTION

End sections blend culvert ends with the slope embankment

HEADWALLS

Headwalls can be constructed of concrete, stone, rip rap stone or steel sheeting.

Pro-Eco-Lite headwalls are engineered from a composite reinforced polymer concrete. They combine the lightweight characteristics of plastic with the strength of concrete. Flow control accessories such as pre-fabricated trash racks, security grids and handrails, bolt-on scour aprons, pre-fabricated weir boards and frames, and pre-installed flap gates and slide gates can be added to enhance performance without affecting appearance.

For large SteelCor pipe, headwalls constructed of Armtec sheeting combined with wing walls constructed from Armtec Bin-Wall provide an economic solution.

CUT-OFF WALLS

Armtec steel sheeting can be used as cut-off walls under the SteelCor pipe inlet and outlet. Depth of cut-off is usually 1m to 1.5m below the invert. Steel sheeting can often be used as a partial headwall with clay or other materials used to further seal the embankment.



PRO ECO-LITE HEADWALL



SHEETING HEADWALL

SPECIFICATIONS

Table 13: End Sections for Pipe-Arch Shapes

Span x Rise	Equiv. Round	Thickness	A	B	H	L	W	Approx. Slope	Weight
mm	mm		mm	mm	mm	mm	mm		kg
560 x 420	450	1.6	180	255	150	585	915	2-1/2	15
680 x 500	600	1.6	230	355	150	810	1,220	2-1/2	24
910 x 660	800	2.0	255	405	200	990	1,525	2-1/2	42
1,030 x 740	900	2.0	305	455	230	1,170	1,905	2-1/2	60
1,150 x 820	1,000	2.8	330	535	305	1,345	2,160	2-1/2	106
1,390 x 970	1,200	2.8	455	660	305	1,600	2,285	2-1/2	143
1,630 x 1,120	1,400	2.8/3.5	455	840	305	1,955	2,895	1-1/2	218
1,880 x 1,260	1,600	2.8/3.5	455	915	305	1,955	3,200	1-1/2	283
2,130 x 1,400	1,800	2.8/3.5	455	990	305	1,955	3,505	1-1/2	304

PLAN

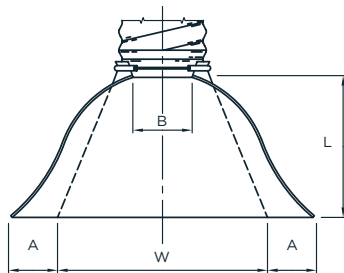

ELEVATION

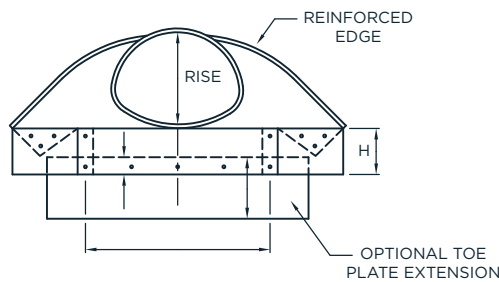

TYPICAL CROSS SECTION

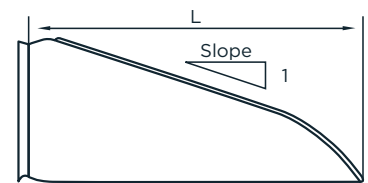

SPECIFICATIONS

Table 14: End Sections for Round Pipe Shapes

Pipe Diameter	Thickness	A	B	H	L	W	Approx. Slope	Weight
mm		mm	mm	mm	mm	mm		kg
300	1.6	175	150	150	530	610	2-1/2	11
400	1.6	200	200	150	660	760	2-1/2	15
450	1.6	200	255	150	785	915	2-1/2	19
500	1.6	230	300	150	915	1,065	2-1/2	22
600	1.6	255	330	150	1,040	1,220	2-1/2	29
800	2.0	305	405	200	1,295	1,525	2-1/2	56
900	2.0	355	480	230	1,525	1,830	2-1/2	61
1,000	2.8	405	560	280	1,750	2,135	2-1/2	145
1,200	2.8	460	685	305	1,980	2,285	2-1/4	170
1,400	2.8	460	760	305	2,135	2,590	2-1/4	200
1,600	2.8/3.5	460	915	305	2,210	3,050	2	316
1,800	2.8/3.5	460	990	305	2,210	3,200	2	327
2,000	2.8/3.5	460	1,065	305	2,210	3,350	1-1/2	367
2,200	2.8/3.5	460	1,145	305	2,210	3,505	1-1/2	386
2,400	2.8/3.5	635	890	305	2,210	3,810	1-1/2	447

PLAN

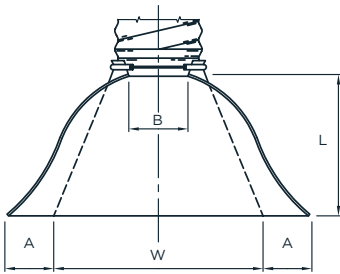

ELEVATION

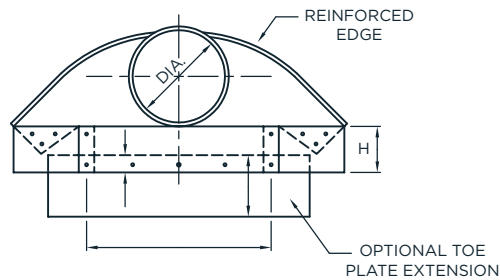

TYPICAL CROSS SECTION

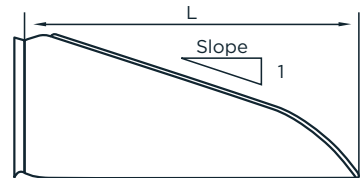

FLANGE NESTABLE PIPE

Flange nestable Corrugated Steel Pipe (CSP) consists of half-round 610 mm long sections with side flanges that can be easily bolted together to form a circular corrugated steel pipe. Nestable pipe is typically galvanized and therefore highly durable under normal conditions. Aluminized Steel Type 2 is also available for added durability.

Flange nestable pipe sections are shipped nested and bundled together to save space during shipping. This is ideal for remote locations and overseas projects where shipping of factory-made pipe would be uneconomical. Flange nestable CSP is useful where a casing is to be installed around an existing utility without disrupting its operation.

TYPICAL APPLICATIONS

- Culverts
- Storm Sewers
- Drains
- Casings
- Utilidors



ECONOMICAL

Sections are nested and bundled together for economical shipping



DURABLE

Available in Aluminized Steel Type 2 for added protection and extended service life



VERSATILE

Suitable for a wide range of applications

FLANGE NESTABLE PIPE

Assembly

Flanged Nestable Pipe is easily assembled and no special instructions are necessary. Simple tools such as spud or socket wrenches are all that are required.

Five corrugation long pieces are used on the top at both ends to introduce a circumferential seam stagger. The 50mm wide flanges have slotted holes spaced at 68mm centre to centre on both sides and are bolted together using galvanized 10mm diameter bolts and nuts. All circumferential laps should be assembled in the direction of fluid flow.



FLANGE NESTABLE PIPE REQUIRES ONLY SIMPLE TOOLS FOR ASSEMBLY



NESTABLE PIPE IS IDEAL FOR MINING APPLICATIONS



NESTED SECTIONS ARE BUNDLED FOR ECONOMICAL TRANSPORTATION

Table 15: FlangeNestable Pipe Height of Cover Table - Live Load - AASHTO H-25 and CS-625

Diameter mm	Area mm ²	Minimum Cover mm	Maximum Height of Cover (m) for Following Specified Wall Thickness		
			1.6mm	2.0mm	2.8mm
300	0.17	300	9.0	-	-
400	0.13	300	9.0	-	-
450	0.16	300	6.0	9.0	-
500	0.20	300	6.0	9.0	-
600	0.28	300	4.5	9.0	-
700	0.38	300	-	7.5	9.0
800	0.50	300	-	6.0	9.0
900	0.64	300	-	6.0	9.0
1,000	0.79	300	-	4.5	9.0
1,200	1.13	300	-	-	7.5
1,400	1.51	500	-	-	6.0
1,600	2.01	500	-	-	4.5

NOTES:

STRUCTURES SHOULD BE BACKFILLED WITH WELL COMPACTED GRANULAR BACKFILL TO A MINIMUM OF 95% STANDARD PROCTOR DENSITY. E-80 LOADING CAN ALSO BE MET. PLEASE CONTACT AN ARMTEC REPRESENTATIVE FOR FURTHER DETAILS.

Table 16: Flange Nestable Pipe Approximate Weights (kg/m)

Diameter mm	Approximate Weight (kg/m) for Following Specified Wall Thickness		
	1.6mm	2.0mm	2.8mm
300	18	22	-
400	22	28	-
450	24	31	43
500	27	34	48
600	31	39	54
700	36	45	62
800	41	51	70
900	45	56	77
1,000	48	61	83
1,200	59	74	102
1,400	68	85	118
1,600	78	97	134

SPECIFICATIONS

Half round sections are manufactured from 68mm x 13mm corrugated steel:

- Corrugations and steel thickness per ASTM A 760A, CSA G401, AASHTO M 36
- Galvanized and Aluminized Type 2 per ASTM A 929A, AASHTO M 218-87
- Zinc coating mass will not be less than 610 g/m² per AASHTO M 218
- Milling sampling and marking per ASTM A924 A 924M
- Minimum aluminum coating thickness of 47µm
- Installation per ASTM A798
- Hardware is zinc plated

ATLANTIC

Shediac, NB
Sackville, NB
Truro, NS
Bishop's Falls, NL
St. John's, NL

CENTRAL

Cambridge, ON
Comber, ON
Forest, ON
Guelph, ON
Peterborough, ON
Sudbury, ON
Thunder Bay, ON
Tillsonburg, ON
Walkerton, ON
St-Augustin, QC
St-Clet, QC

PRAIRIES

Calgary, AB
Edmonton, AB
Grande Prairie, AB
Ponoka, AB
Redwater, AB
Winnipeg, MB
Regina, SK
Saskatoon, SK

WESTERN

Dawson Creek, BC
Genelle, BC
Langley, BC
Nanaimo, BC
Prince George, BC



Find out how **Corrugated Steel (CSP) Pipe** can be used
on your next project.

Call **1-800-565-1152** or visit **armtec.com**

